

21310 EK

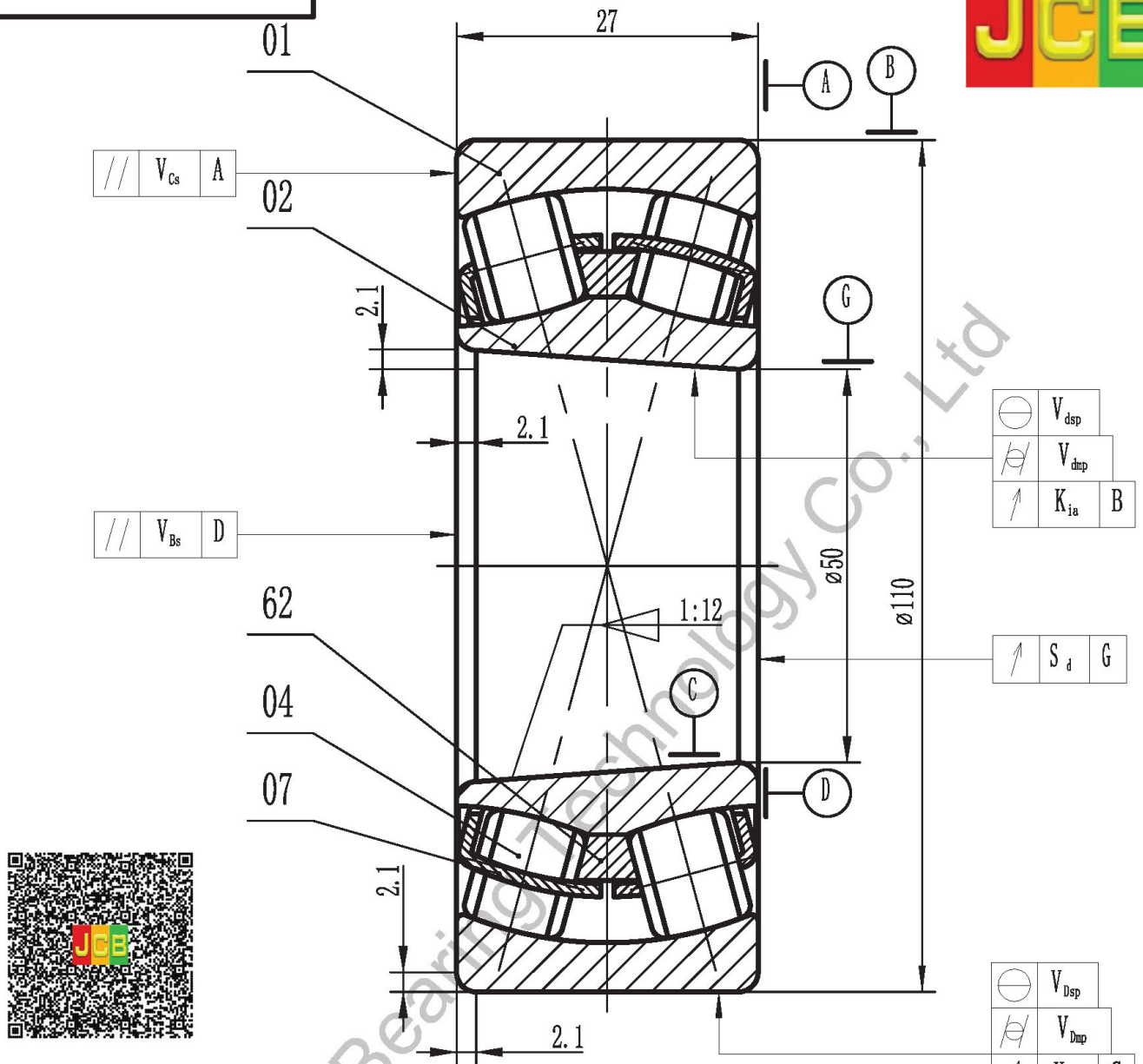

1. Tolerance of running accuracy are according to relevant state standard;
2. The value of the basic group of radial clearance: min 0.100 max 0.135;
3. Rated load: Cr=640 kN Cor=740 kN.

62	Guide ring		Steel 20—GB699			
07	Cage		Steel St 52—EN 10025:1990 + A:1993			
04	Roller		Steel 100Cr6—ISO 683-17:1999			
02	Inner ring		Steel 100Cr6—ISO 683-17:1999			
01	Outer ring		Steel 100Cr6—ISO 683-17:1999			
No.	Name	Qty	Material	Unit	Total	Remark
				Weight (kg)		

Luoyang JCB Bearing Technology Co., Ltd  
 Contact information  
 Company Address : No. 285, Fenghua road,  
 Luoyang, Henan, China.  
 Postal code : 471000  
 Phone : 86-379-68611678  
 Fax : 86-379-68611679  
 E-mail: sales@jcb-bearing.com  
 Reserved E-mail: sales@sphericalrollerbearing.net  
 Website: www.jcb-bearing.com  
 www.sphericalrollerbearing.net

## Spherical Roller Bearing

21310 EK

Weight (kg) Scale

S

Total page 6 Page No. 1

Luoyang JCB Bearing Technology Co., Ltd